

Invacare® Softform Active® 2 Rx

en Powered Hybrid Support Surface
Service Manual



PROVIDER: **Keep** this manual.
The procedures in this manual **MUST** be performed by a qualified technician.



Contents

1 General	3
1.1 Introduction	3
1.2 Symbols in This Manual	3
1.3 Preliminary System Check	3
2 Safety	4
2.1 General Safety Information	4
2.2 Personal Safety Information	4
2.3 Electrical Safety Check	4
3 Digital Control Unit	5
3.1 Components' Overview	5
3.2 Circuit Board (PCB) Overview	5
4 Service Digital Control Unit	6
4.1 Replacing the Front Housing	6
4.2 Replacing the Mains Cable Socket	8
4.3 Replacing the User Interface	8
4.4 Replacing the Compressor	9
4.5 Replacing the PCB	10
4.6 Replacing the CPR Connector	13
4.7 Replacing the Tubing Set	13
4.8 Replacing the Motor	14
4.9 Replacing the Power Switch	15
4.10 Replacing the Bottom Housing	16
4.11 Replacing the Fuses	16
5 Service Mattress	17
5.1 Replacing the CPR Connector	17
5.2 Replacing the Air Cell Set	17

1 General

1.1 Introduction

This document contains important information about assembly, adjustment and advanced maintenance of the product. To ensure safety when handling the product, read this document and the user manual carefully and follow the safety instructions.

Find the user manual on Invacare's website or contact your Invacare representative. See addresses at the end of this document.

Invacare reserves the right to alter product specifications without further notice.

Before reading this document, make sure you have the latest version. You find the latest version as a PDF on the Invacare website.

For pre-sale and user information, see the user manual.

For more information about the product, for example product safety notices and product recalls, contact your Invacare representative. See addresses at the end of this document.

1.2 Symbols in This Manual

Symbols and signal words are used in this document and apply to hazards or unsafe practices which could result in personal injury or property damage. See the information below for definitions of the signal words.



WARNING!

Indicates a hazardous situation that could result in serious injury or death if it is not avoided.



CAUTION!

Indicates a hazardous situation that could result in minor or slight injury if it is not avoided.



NOTICE!

Indicates a hazardous situation that could result in damage to property if it is not avoided.



Tips and Recommendations

Gives useful tips, recommendations, and information for efficient, trouble-free use.



Triman

Indicates recycling and sorting rules (only relevant for France).

1.3 Preliminary System Check



Before commencing any service procedure, the following preliminary verifications should be completed to ensure the system fault or failure is not due to a user oversight.

1. Confirm the mains cable is firmly attached and the system is connected to a working power source.
2. Make sure the handle is secured to the control unit. All three connectors should be firmly inserted.
3. Remove the mattress top cover. Ensure the cardiopulmonary resuscitation (CPR) label is firmly attached.
4. Check that each air cell and side bolster is firmly attached to the internal air tubes.

Once the preliminary system check is complete, proceed with the service and repair as outlined in the following procedures.

2 Safety

2.1 General Safety Information

WARNING!
Risk of injury or damage to property

- The procedures in this manual must only be performed by a qualified technician.
- Use only original accessories and spare parts.
- Do not handle this product or any available optional equipment without first completely reading and understanding these instructions and any additional instructional material such as user manuals, installation manuals or instruction sheets supplied with this product or optional equipment.
- After each assembly, check that all fittings are properly tightened and that all parts have the correct function.

WARNING!
Risk of contamination

- Clean and disinfect the product before servicing.

NOTICE!

Assembly of accessories might not be described in this service manual. Refer to the manual, delivered with the accessory.

- Additional manuals can be ordered from Invacare. See addresses at the end of this document.

NOTICE!

Replacement parts for this product family are only available as a kit. Always use the complete new kit when replacing a part.

- Spare parts kits can be ordered from Invacare. Refer to your local Invacare website to access the electronic spare parts catalogue (ESPC).

NOTICE!

Refer to the user manual of this product for information on:

- Technical Data
- Product Components
- Labels
- Additional safety instructions
- Cleaning and disinfection instructions

NOTICE!

When components are replaced, it is necessary to ensure their traceability by keeping the original serial number in the control unit (replacement of spare parts with serial numbers).

- Ensure the serial number traceability by either printing a new serial label or transferring the existing one, and placing it in the replacement part.



The information contained in this document is subject to change without notice.

2.2 Personal Safety Information

These safety instructions are intended to help avoid accidents during work and must be observed under all circumstances.

All employees coming into contact with contaminated products must regularly consult a company doctor. Work clothing and personal protective equipment must be available in necessary quantities and be in proper condition. Reliable hand and surface disinfection must be ensured.

WARNING!
Risk of contamination

- Clean and disinfect the product before carrying out repairs.

2.3 Electrical Safety Check

NOTICE!

Regular electrical checks according to EN 62353 (VDE0751) must be carried out in line with national requirements.

Inspect all electronic components for damage to the casing or cable, test functions and check for stray current.

3 Digital Control Unit

3.1 Components' Overview



A	User's Interface
---	------------------

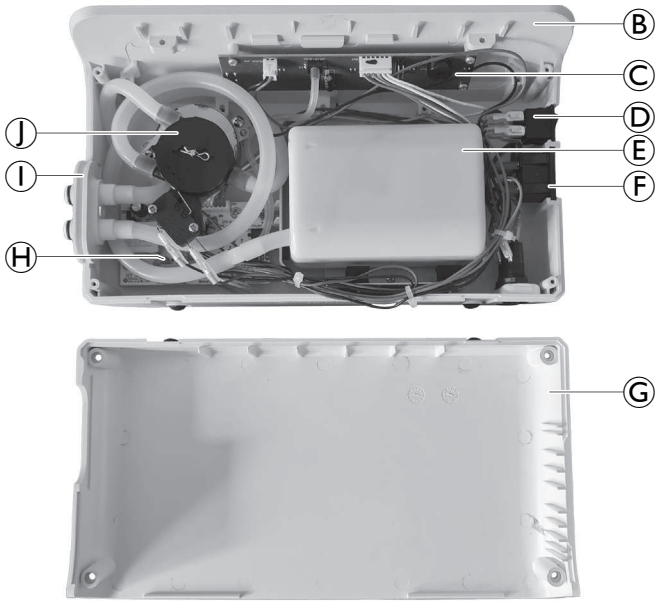

B	Top Housing
C	User's interface circuit board (UIPCB)
D	Power (on/off) switch
E	Compressor
F	IEC ¹ Mains socket
G	Bottom housing
H	Circuit board (PCB)
I	Air tube connector
J	Motor

¹ International Electrotechnical Commission Standards

3.2 Circuit Board (PCB) Overview

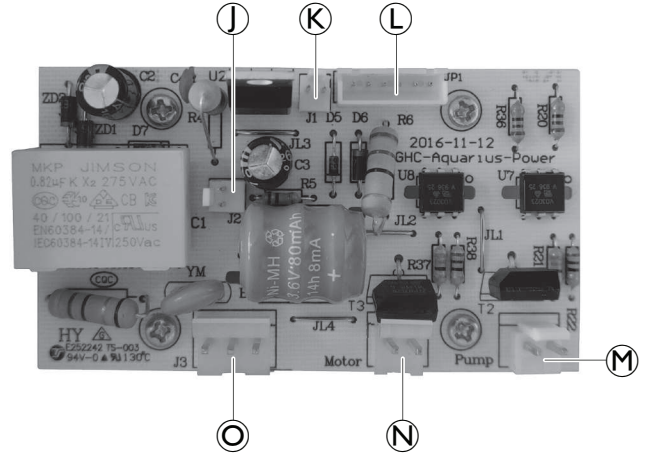

J	Power switch connector
K	Micro switch connector
L	6-pin user's interface connector
M	Compressor connector
N	Motor connector
O	Fuses connector

4 Service | Digital Control Unit

4.1 Replacing the Front Housing

Refers to spare parts kit SP1633237

! **NOTICE!**
Risk of damaging the PCB by electro-static discharge
 Handle PCBs only in Electrostatic Protected Areas

 PH1 Philips Key
 14 mm Open-ended wrench

1. Switch off the control unit and disconnect from mains supply.
2. Turn the unit upside down.
3. Loosen and remove the four screws **A**.



4. Remove the bottom housing.
5. Loosen and remove the two screws **B** fixing the motor to the front housing.

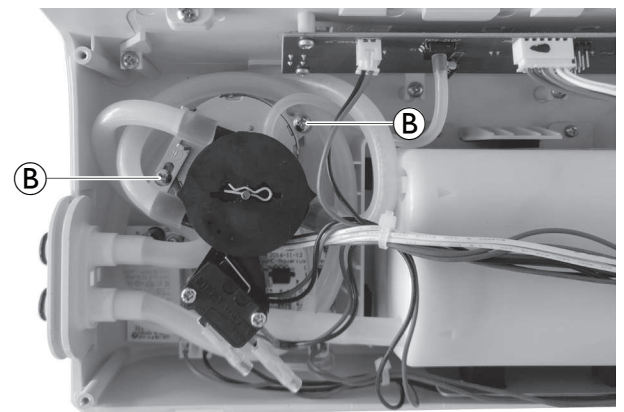

6. Loosen and remove the three screws **C** fixing the compressor to the front housing.

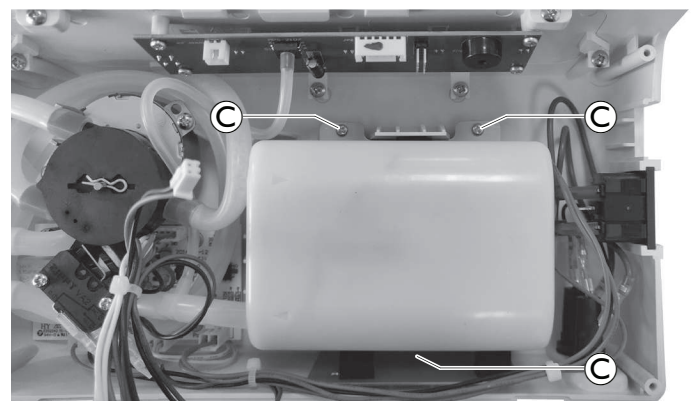

7. Loosen and remove the four screws ④ fixing the PCB to the front housing.
8. Unplug all wires.

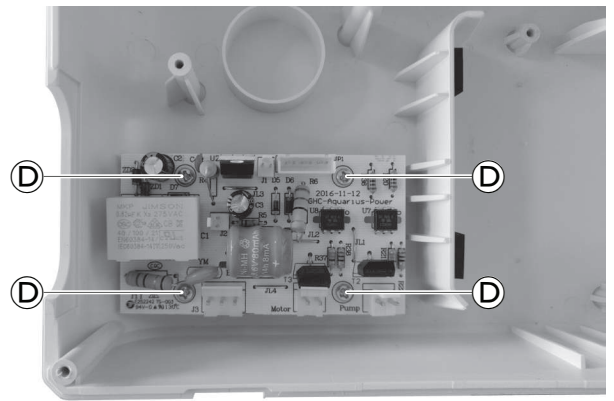

9. Unplug the four wires - brown ⑤, black ⑥, red ⑦ and blue ⑧ - connected to the fuse holders ⑩, located on the front housing's bottom right side.

! NOTICE!
Risk of malfunction or damage to the Control Unit
 Ensure the brown ⑤, black ⑥, red ⑦ and blue ⑧ wires are plugged back into their original positions.

10. Using the indicated wrench, loosen and remove the fuse holders ⑩ from the front housing.
11. Remove the digital control's label from the front housing.

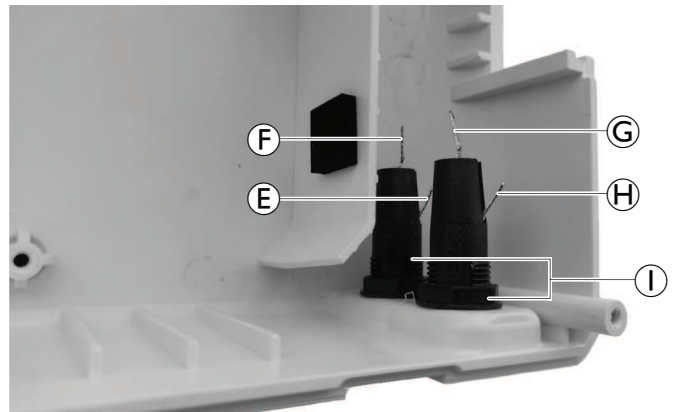

12. Loosen and remove the seven screws ⑪ from the front housing.
13. Remove the User's interface from the front housing. Discard the defective front housing.
14. Place the User's interface in the new front housing. Position and tighten the provided screws.

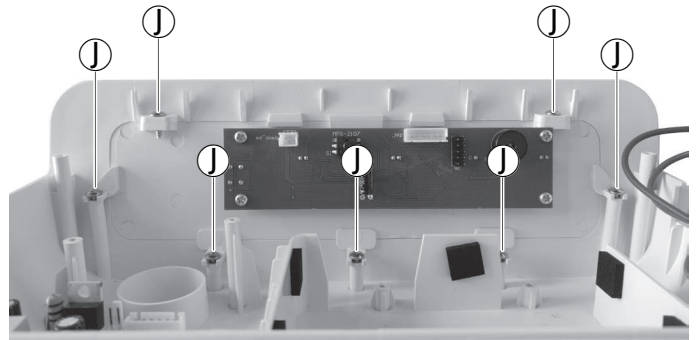

15. Place the unit with the Invacare logo facing forward and install the new digital control's stick-on label as illustrated.
16. Place and secure the remaining components on the new front housing in the reverse order to which they have been removed from the old one (see steps 5 to 10).
17. Reinstall the bottom housing.



4.2 Replacing the Mains Cable Socket

Refers to spare parts kit SP1633237

! **NOTICE!**
Risk of damaging the PCB by electro-static discharge
 Handle PCBs only in Electrostatic Protected Areas

 PH1 Philips Key

1. Switch off the control unit and disconnect from mains supply.
2. Remove the bottom housing (see 4.1 Replacing the Front Housing, page 6, step 4).
3. Unplug the brown **A** and blue **B** wires from the defective mains socket.

! **NOTICE!**
Risk of malfunction or damage to the Control Unit
 Ensure the brown **A** and blue **B** wires are plugged back into their original positions.

4. Plug the brown **A** and blue **B** wires to the new mains socket **C**, ensuring they are installed in the original position. Slide the socket into its slit.
5. Reinstall the bottom housing.

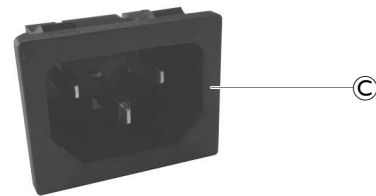
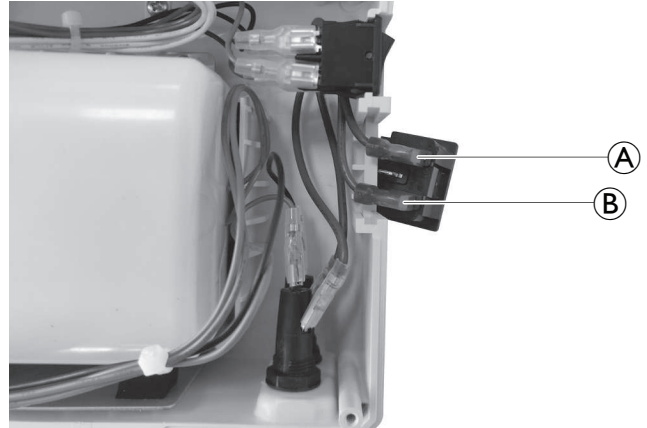

4.3 Replacing the User Interface

Refers to spare parts kit SP1633237

! **NOTICE!**
Risk of damaging the PCB by electro-static discharge
 Handle PCBs only in Electrostatic Protected Areas

 PH1 Philips Key

1. Switch off the control unit and disconnect from mains supply.
2. Remove the bottom housing (see 4.1 Replacing the Front Housing, page 6, step 4).
3. Remove the user's interface label from the front housing.



- Unplug wires (A), silicone tube (B), and wires (C) from the UIPCB.

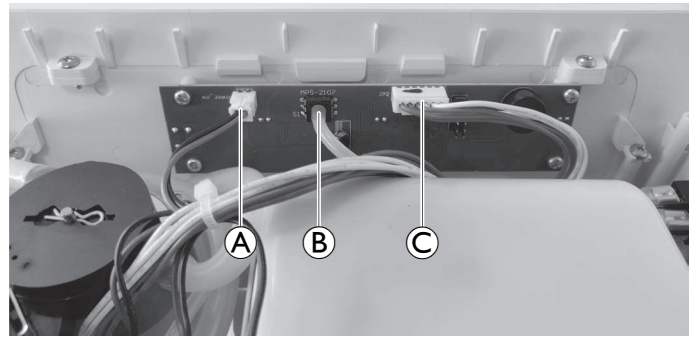



- Loosen and remove the seven screws fixing the interface label to the front housing (see 4.1 Replacing the Front Housing, page 6, step 12).
- Remove the non-functioning UIPCB from the housing.
- Install the new User's interface, which includes a new - already attached - UIPCB, on the front housing.
- Position and tighten the provided screws.
- Plug wires (A), silicone tube (B), and wires (C) into the new UIPCB.
- Reinstall the bottom housing (see 4.1 Replacing the Front Housing, page 6).
- Place the unit with the Invacare logo facing forward and install the new digital control's stick-on label as illustrated.



4.4 Replacing the Compressor

Refers to spare parts kit SP1633237

! **NOTICE!**
Risk of damaging the PCB by electro-static discharge
 Handle PCBs only in Electrostatic Protected Areas

 PH1 Philips Key
 Wire clippers

- Switch off the control unit and disconnect from mains supply.
- Remove the bottom housing (see 4.1 Replacing the Front Housing, page 6, step 4).
- Loosen and remove the three screws (A) fixing the compressor to the front housing.

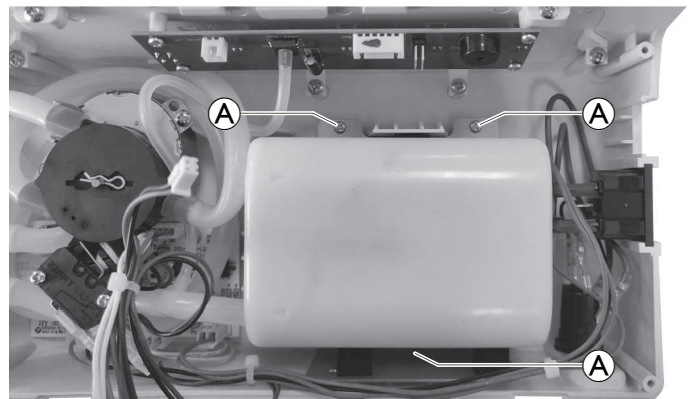

- Carefully unplug the silicone tube **B** and cut the cable tie **C** using the wire clippers.

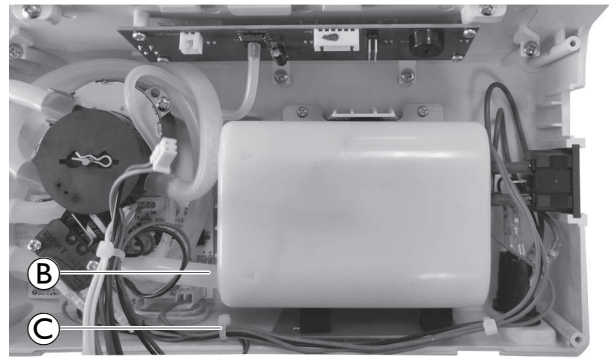

- Unplug the compressor wire **D** from the PCB.
- Remove the non-functioning compressor from the housing and install the new one.
- Position and tighten the provided screws
- Plug the silicone tube to the compressor.
- Plug the mains wire to the PCB.
- Secure the wires with the provided cable ties.
- Cut the excess cable tie length.
- Reinstall the bottom housing.

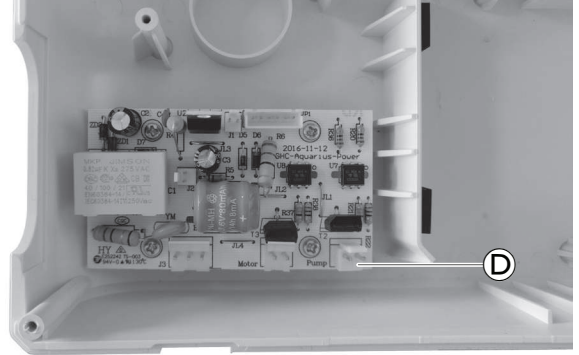

4.5 Replacing the PCB

Refers to spare parts kits: SP1633122 (240V) / SP1633116 (110V)

NOTICE!
Risk of damaging the PCB by electro-static discharge
 Handle PCBs only in Electrostatic Protected Areas

 PH1 Philips Key

- Switch off the control unit and disconnect from mains supply.
- Remove the bottom housing (see 4.1 *Replacing the Front Housing, page 6, step 4*).
- Unplug silicone tube **A** connecting the T-valve to the compressor, tube **B** from the CPR connector, and the pressure tube **C** from the UIPCB.
- Remove the CPR connector from its slit and untangle the silicone tubes around the motor.

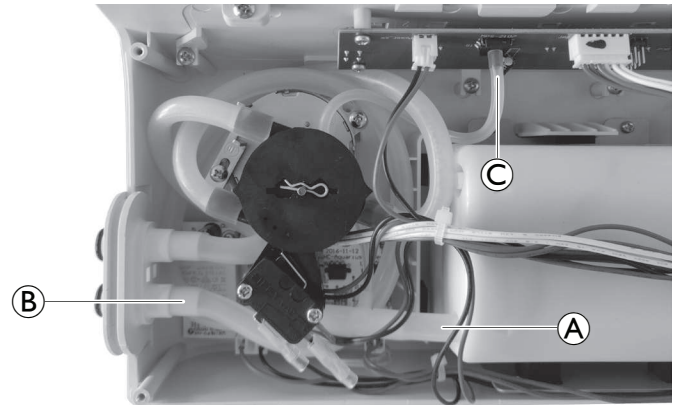

5. Unplug the black and green wires ④ from the microswitch.
6. Loosen and remove the four screws fixing the PCB to the front housing.

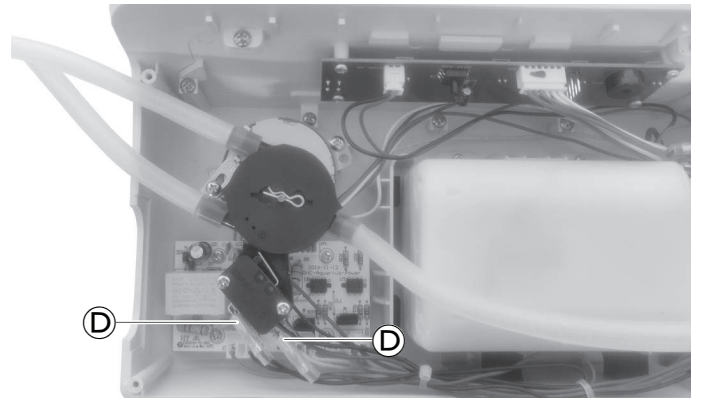

7. Unplug the yellow motor wire ⑤ from the PCB.
8. Slide the PCB from under the microswitch and remove it from the housing. Unplug the five remaining wires from the PCB. Discard the non-functioning PCB.

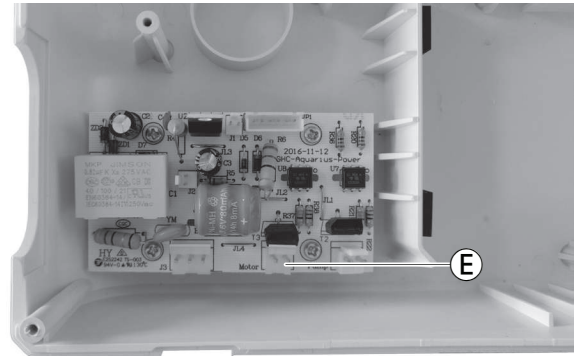

9. Connect the five cables to the new PCB, in their original position: green and black power switch wire ⑥, green and black micro switch wire ③, 6-pin user interface wire ⑧, red compressor wires ① and red and black fuse holder wire ②.
10. Install the new PCB on the front housing, ensuring the yellow motor wire ⑤ goes under it.
11. Install the provided screws and tighten them.
12. Plug the yellow motor wire to its original position.
13. Plug the microswitch wires (see step 5).

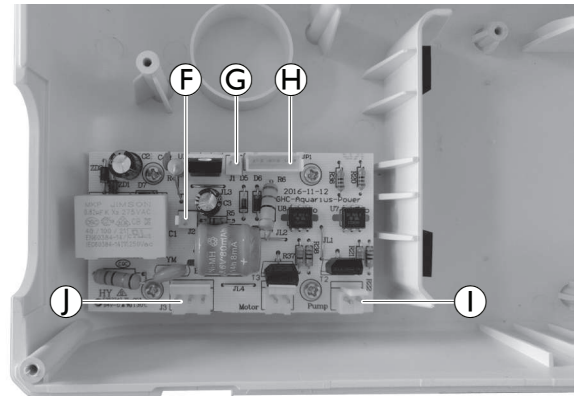

14. Place the longer silicone tube (the one with the T-valve) counterclockwise around the motor.

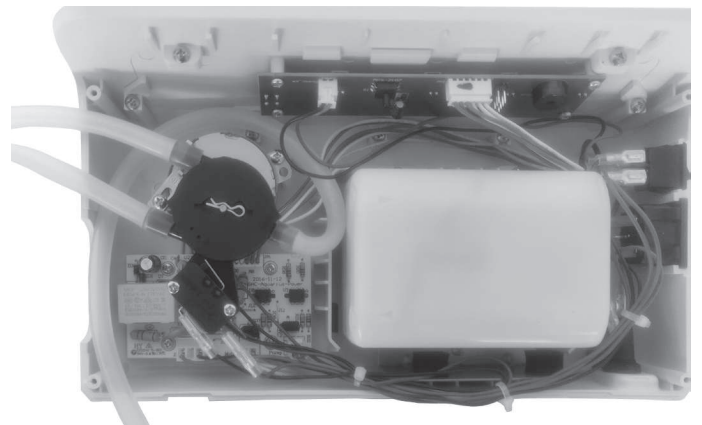

15. Pick the longer tube connected to the CPR connector, put it around the motor, clockwise, and plug it back to the connector, threading it under the microswitch wires ④.

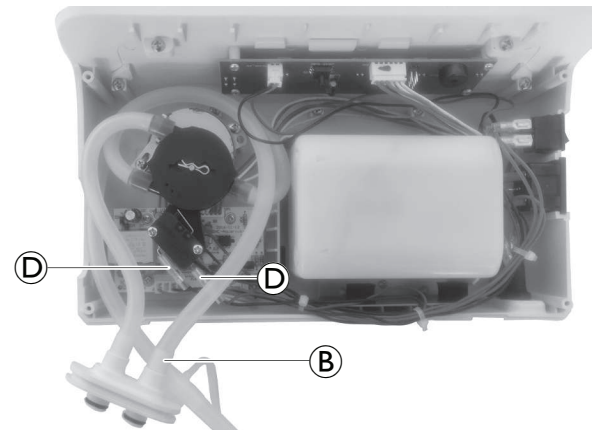

16. Install the CPR connector in its place, making sure the longer silicone tube is underneath.

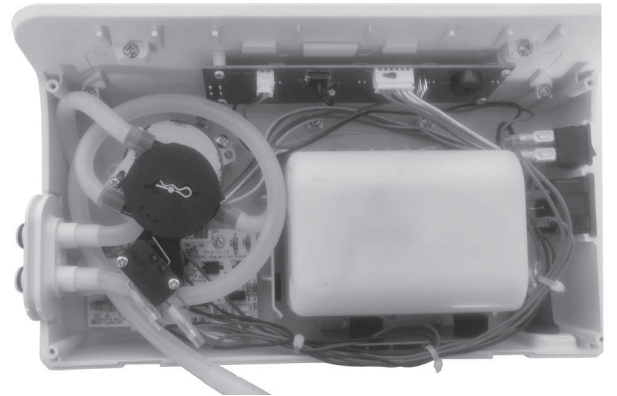

17. Slide the T-valve underneath the microswitch, connect the wider tube to the compressor and the thinner one to the user interface, making sure it goes under all the other tubes.
18. Reinstall the bottom housing.

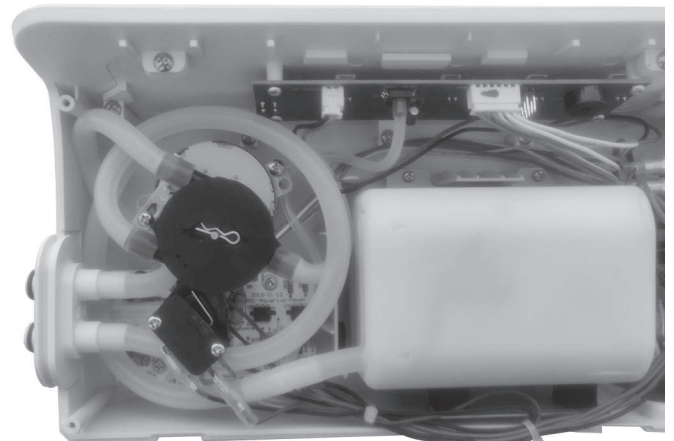

4.6 Replacing the CPR Connector

Refers to spare parts kit SP1633238

! **NOTICE!**
Risk of damaging the PCB by electro-static discharge
 Handle PCBs only in Electrostatic Protected Areas

 PH1 Philips Key

1. Switch off the control unit and disconnect from mains supply.
2. Remove the bottom housing (see 4.1 Replacing the Front Housing, page 6, step 4).
3. Unplug both silicone tubes A from the connector.
4. Discard the defective connector.
5. Reinstall the silicone tubes to the new connector and slide it into the slit. Ensure no tube is kinked or clamped.
6. Reinstall the bottom housing.

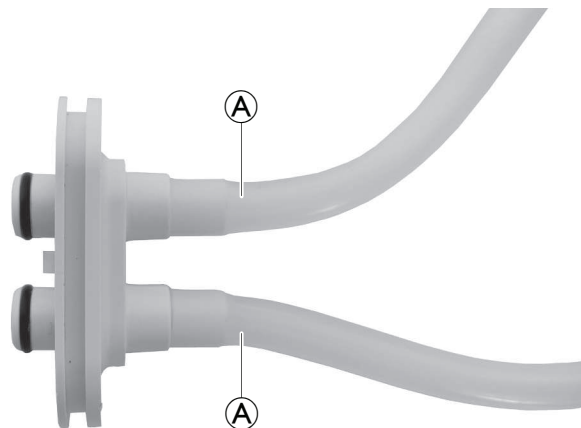

4.7 Replacing the Tubing Set

Refers to spare parts kit SP1633112

! **NOTICE!**
Risk of damaging the PCB by electro-static discharge
 Handle PCBs only in Electrostatic Protected Areas

 PH1 Philips Key

1. Switch off the control unit and disconnect from mains supply.
2. Remove the bottom housing (see 4.1 Replacing the Front Housing, page 6, step 4).
3. Unplug tubes Ⓐ to Ⓒ. Discard them.
4. Install the 320 mm long tube on one side of the T-valve and the 40 mm long tube on the opposite side. Connect the third (smaller diameter) tube both to the T-valve and to the UIPCB.
5. Install remaining tubes to their original positions (see 4.5 Replacing the PCB, page 10, steps 14 - 17).
6. Reinstall the bottom housing.

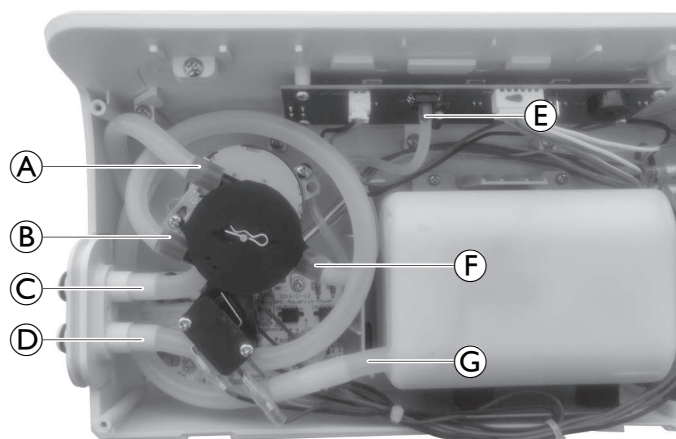

4.8 Replacing the Motor

Refers to spare parts kit SP1633126 (240V) / SP1633120 (110V)

! **NOTICE!**
Risk of damaging the PCB by electro-static discharge
 Handle PCBs only in Electrostatic Protected Areas

 PH1 Philips Key

1. Switch off the control unit and disconnect from mains supply.
2. Remove the bottom housing (see 4.1 Replacing the Front Housing, page 6, step 4).
3. Unplug the three silicone tubes **(A)** connected to the motor.

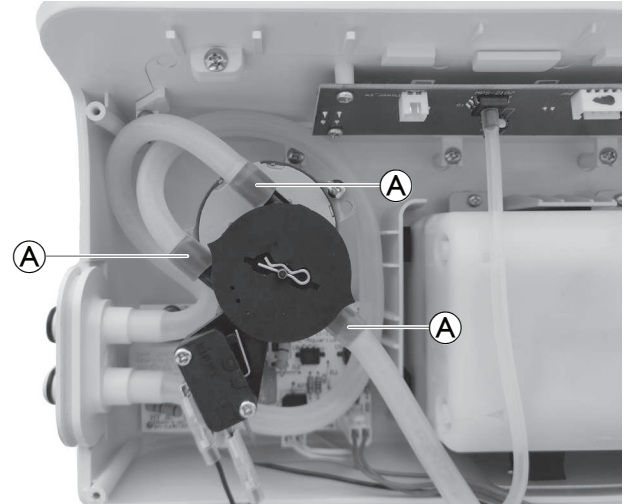

4. Unplug the black **(B)** and green **(C)** wires from the microswitch.

! **NOTICE!**
Risk of malfunction or damage to the Control Unit
 Ensure the black **(B)** and green **(C)** wires are plugged back into their original positions.

5. Unplug the yellow motor wire from the PCB (see the third image in 4.5 Replacing the PCB, page 10).

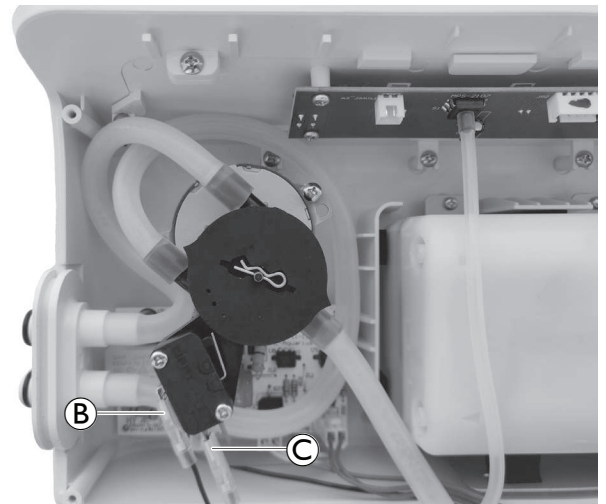

6. Loosen and remove the screws **(D)** fixing the motor to the front housing.
7. Discard the non-functioning motor.
8. Install the new motor on its position.
9. Position and tighten the provided screws.
10. Plug tubes **(A)** and the wires to the new motor.
11. Reinstall the bottom housing.

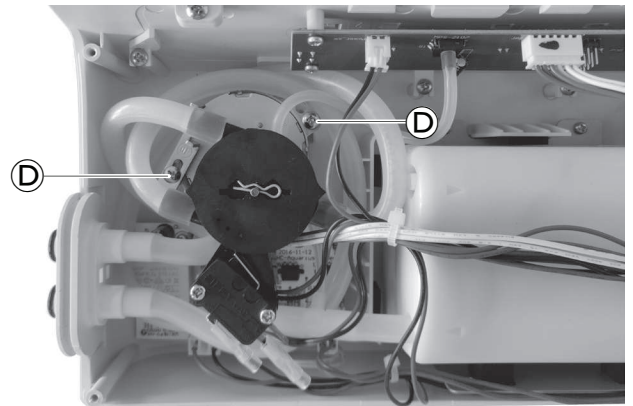

4.9 Replacing the Power Switch

Refers to spare parts kit SP1633123 (240V) / SP1633117 (110V)

! **NOTICE!**
Risk of damaging the PCB by electro-static discharge
 Handle PCBs only in Electrostatic Protected Areas

 PH1 Philips Key

1. Switch off the control unit and disconnect from mains supply.
2. Remove the bottom housing (see 4.1 Replacing the Front Housing, page 6, step 4).
3. Unplug the red (A), green (B) and two black (C) wires from the defective power switch. Discard it.

! **NOTICE!**
Risk of malfunction or damage to the Control Unit
 Ensure the red (A), green (B) and two black (C) wires are plugged back into their original positions.

4. Plug the red (A), green (B) and two black (C) wires back to their original positions on the new power switch.
5. Slide the switch into the slit.
6. Reinstall the bottom housing.

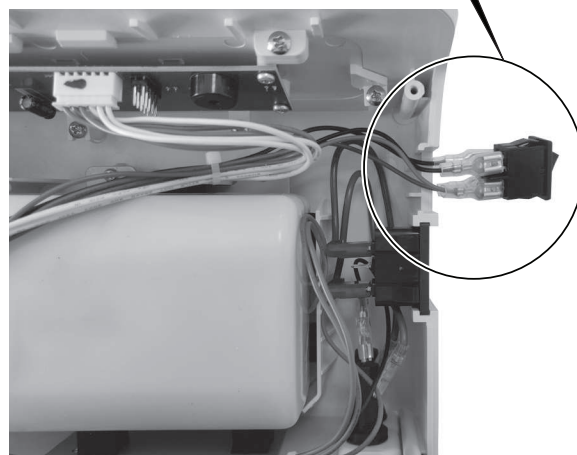
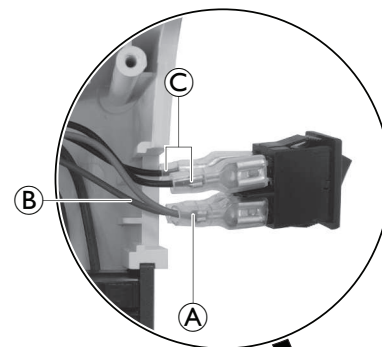

4.10 Replacing the Bottom Housing

Refers to spare parts kit SP1633246 (240V) / SP1634532 (110V)

! **NOTICE!**
Risk of damaging the PCB by electro-static discharge
 Handle PCBs only in Electrostatic Protected Areas

 PH1 Philips Key

1. Switch off the control unit and disconnect from mains supply.
2. Remove the bottom housing (see 4.1 Replacing the Front Housing, page 6, step 4).
3. Ensure the serial number traceability by carefully removing the serial label from the old bottom housing and placing it in the replacement one. Install the blue label on top of the serial label, ensuring the latter stays visible.
4. Install the new bottom housing.
5. Position and tighten the provided screws.

4.11 Replacing the Fuses

Refers to spare parts kit SP1633143

 PH1 Philips Key

1. Switch off the control unit and disconnect from mains supply.
2. Turn the unit upside down.
3. Unscrew the fuse holders . Remove them from the unit.
4. Remove the fuses from their holders. Discard the defective fuses.
5. Install the new fuses on their holders.
6. Position the fuse holders back to the unit and tighten them.



5 Service | Mattress

5.1 Replacing the CPR Connector

Refers to spare parts kit SP1633237

1. Switch off the control unit and disconnect from mains supply.
2. Open the zipper of the mattress and remove the top cover.
3. Remove the orange castellated foam insert.
4. Find the CPR connector at the mattress foot end. Unplug it at the tube's extremities (A).
5. Slide the defective connector off its sleeve and replace it with the new one.
6. Plug the new connector onto the tube extremities.
7. Place the foam insert back on top of the mattress and close the mattress cover's zipper.

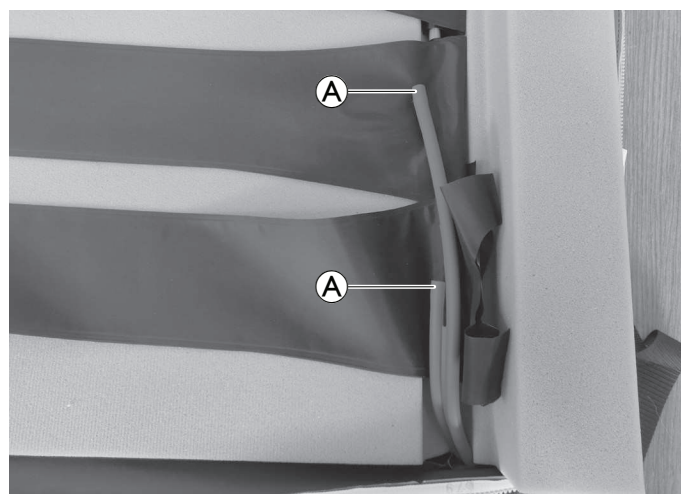

5.2 Replacing the Air Cell Set

Refers to spare parts kit SP1627630 / SP1629718 / SP1629719

1. Switch off the control unit and disconnect from mains supply.
2. Open the zipper of the mattress and remove the top cover.
3. Remove the orange castellated foam insert.
4. Find the CPR connector at the mattress foot end. Unplug it at the tube's extremities (see 5.1 Replacing the CPR Connector, page 17).
5. Detach the tubes connected to the T-valve (A) located on the penultimate air cell.
6. Slide the T-valve through the strap's hole.
7. Thread the strap through the buckle (B) positioned on the blue foam's lower side.
8. Discard the defective air cell set.
9. Repeat steps 5 to 7 for the five remaining T-valves.
10. Install the new air cell set and secure it with the provided straps and buckles.
11. Place the foam layer back on top of the mattress and close the mattress cover's zipper.

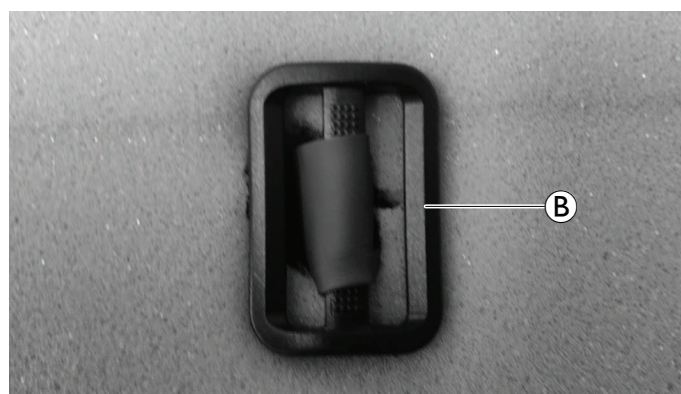
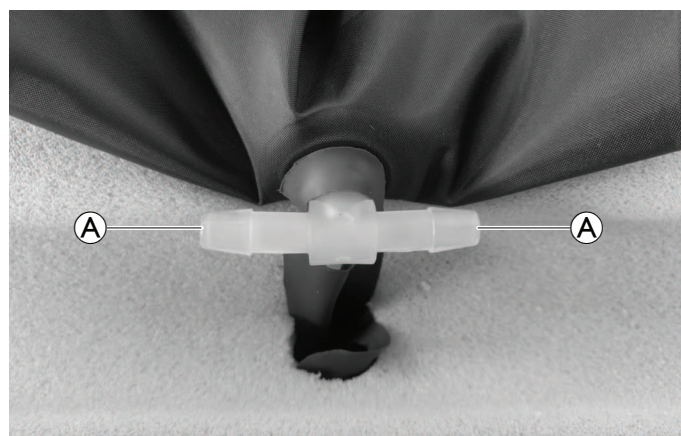

**United Kingdom & Ireland:**

Invacare Limited
 Pencoed Technology Park, Pencoed
 Bridgend CF35 5AQ
 Tel: (44) (0) 1656 776 200
 uk@invacare.com
 www.invacare.co.uk

Belgium & Luxemburg:

Invacare nv
 Autobaan 22
 B-8210 Loppem
 Tel: (32) (0)50 83 10 10
 Fax: (32) (0)50 83 10 11
 marketingbelgium@invacare.com
 www.invacare.be

Danmark:

Invacare A/S
 Sdr. Ringvej 37
 DK-2605 Brøndby
 Tel: (45) (0)36 90 00 00
 Fax: (45) (0)36 90 00 01
 denmark@invacare.com
 www.invacare.dk

Deutschland:

Invacare GmbH
 Am Achener Hof 8
 D-88316 Isny
 Tel: (49) (0)7562 700 0
 kontakt@invacare.com
 www.invacare.de

Österreich:

Invacare Austria GmbH
 Herzog-Odilo-Straße 101
 A-5310 Mondsee
 Tel: (43) 6232 5535 0
 Fax: (43) 6232 5535 4
 info-austria@invacare.com
 www.invacare.at

Schweiz / Suisse / Svizzera:

Invacare AG
 Neuhofweg 51
 CH-4147 Aesch BL
 Tel: (41) (0)61 487 70 80
 Fax: (41) (0)61 488 19 10
 switzerland@invacare.com
 www.invacare.ch

España:

Invacare S.A.
 Avenida del Oeste, 50 – 1^º-1a
 Valencia-46001
 Tel: (34) 972 493 214
 contactsp@invacare.com
 www.invacare.es

France:

Invacare Poirier SAS
 Route de St Roch
 F-37230 Fondettes
 Tel: (33) (0)2 47 62 64 66
 contactfr@invacare.com
 www.invacare.fr

Italia:

Invacare Mecc San s.r.l.,
 Via dei Pini 62,
 I-36016 Thiene (VI)
 Tel: (39) 0445 38 00 59
 servizioclienti@invacare.com
 www.invacare.it

Nederland:

Invacare BV
 Galvanistraat 14-3
 NL-6716 AE Ede
 Tel: (31) (0)318 695 757
 nederland@invacare.com
 www.invacare.nl

Norge:

Besøksadresse:
 (Office addresses)
 Invacare AS
 Brynsveien 16
 0667 Oslo
 Tel: (47) 22 57 95 00
 norway@invacare.com
 www.invacare.no

Norge:

Vareleveringsadresse:
 (Storage / Teknical dep)
 Østensjøveien 19
 0661 Oslo
 eknisk@invacare.com
 www.invacare.no

Portugal:

Invacare Lda
 Rua Estrada Velha, 949
 P-4465-784 Leça do Balio
 Tel: (351) (0)225 193 360
 portugal@invacare.com
 www.invacare.pt

Suomi:

Camp Mobility
 Patamäenkatu 5, 33900 Tampere
 Puhelin 09-35076310
 info@campmobility.fi
 www.campmobility.fi

Sverige:

Invacare AB
 Fagerstagatan 9
 S-163 53 Spånga
 Tel: (46) (0)8 761 70 90
 Fax: (46) (0)8 761 81 08
 sweden@invacare.com
 www.invacare.se

EU Export:

Invacare Poirier SAS
 Route de St Roch
 F-37230 Fondettes
 Tel: (33) (0)2 47 62 69 80
 serviceclient_export@invacare.com
 www.invacare.eu.com

Australia:

Invacare Australia Pty. Ltd.
 Unit 18/12 Stanton Road, Seven Hills
 NSW 2147, Australia
 Phone: 1800 460 460
 Fax: 1800 814 367
 orders@invacare.com.au
 www.invacare.com.au

New Zealand:

Invacare New Zealand
 Ltd4 Westfield Place
 Mt Wellington
 1060, New Zealand
 Phone: 0800 468 222
 Fax: 0800 807 788
 sales@invacare.co.nz
 www.invacare.co.nz

USA:

Invacare Corporation
 One Invacare Way
 Elyria, Ohio USA
 44035
 800-333-6900
 www.invacare.com



Invacare UK Operations Limited
 Unit 4, Pencoed Technology Park, Pencoed
 Bridgend CF35 5AQ
 UK



Invacare Portugal, Lda
 Rua Estrada Velha 949
 4465-784 Leça do Balio
 Portugal

60129676-D 2024-02-09

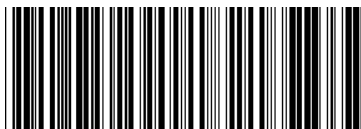
**Making Life's Experiences Possible®****Yes, you can.®**